

480. DIMENSIONADO

N° EXP.

Z	Y	X	

APELLIDOS: _____

NOMBRE: _____

(firma)

HORMIGON HA25 Compresión segura uniforme: $12 \text{ N/mm}^2 = 1,2 \text{ kN/cm}^2$
HORMIGON HM20 Tracción segura: $1,0 \text{ N/mm}^2 = 0,1 \text{ kN/cm}^2$

PILOTES Compresión segura uniforme en fondo: $3,5 \text{ N/mm}^2 = 0,35 \text{ kN/cm}^2$

ACERO DE ARMAR B500 Tensión segura: $310 \text{ N/mm}^2 = 31 \text{ kN/cm}^2$

Longitudes, en metros con DOS decimales. Resto SIN decimales

1

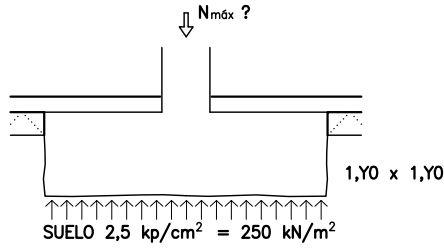

kN

2

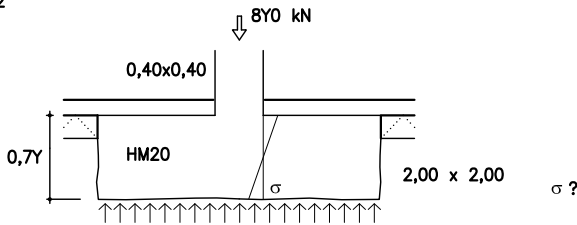

kN/cm^2
DOS cifras significativas

3

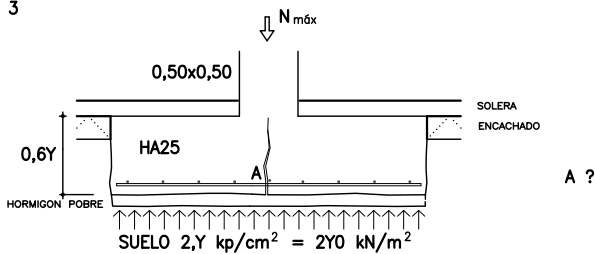

n ϕ

4

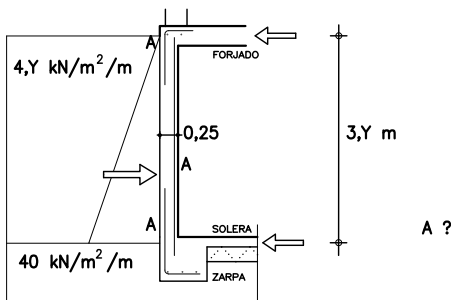

ϕ s

5

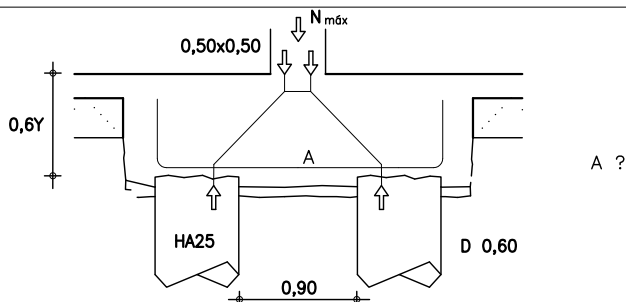

n ϕ

CALCULO DE ZAPATAS CENTRADAS

SUPERFICIE EN PLANTA $S > N/p$ (forma: cualquiera centrada con la carga; p.e. cuadrada axa)

p : presión admisible del suelo, de ordinario 250 kN/m^2

CANTO: el menor posible, en cuanto se alcance el suelo con presión p

ARMADO Si $h > h_m$ Zapata de hormigón en masa, HM20, $h > 0,35$

Si $h < h_m$ Zapata de hormigón armado, HA25, $h > 0,25$ $h > h_a$

$M = N v/4$ (aprox $M = Na/8$) $A = M/zf_s$ ($z = 0,8h$)

A: sección de toda la armadura en esa dirección

$p \text{ (kN/m}^2\text{)}$	150	200	250	300	400	ϕ	$\phi 12$	$\phi 14$	$\phi 16$	$\phi 20$	$\phi 25$
h_m/v	0,8	1,0	1,1	1,2	1,4	l	0,30	0,35	0,40	0,60	0,90
h_a/v	0,3	0,4	0,4	0,5	0,5	Longitud de patilla: $(2l-v)/2$					

$p \text{ (kN/m}^2\text{)}$	150	250	400
$N = 500 \text{ kN}$	$\phi 12/0,20$	$\phi 12/0,15$	$\phi 14/0,15$
$N = 700 \text{ kN}$	$\phi 16/0,25$	$\phi 16/0,20$	$\phi 16/0,15$
$N = 1000 \text{ kN}$	$\phi 16/0,15$	$\phi 16/0,12$	$\phi 20/0,15$

Armado para canto mínimo

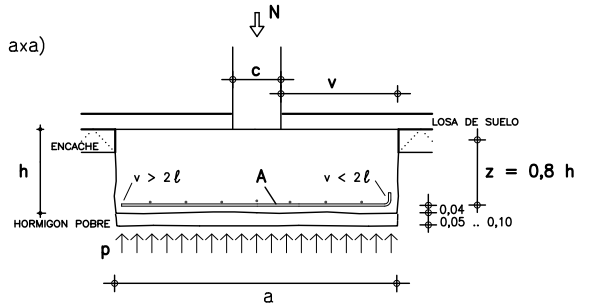

Longitudes, en metros con DOS decimales. Resto SIN decimales

6

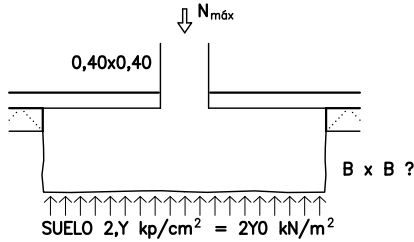
 m x m

7

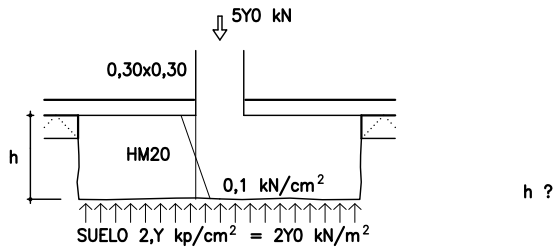
 m

8

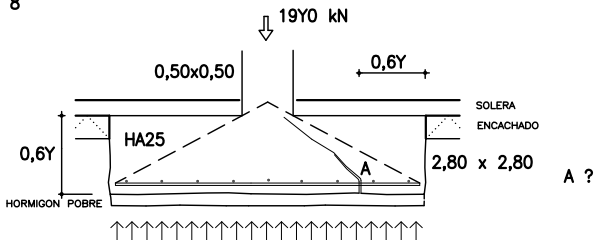
 n ϕ

9

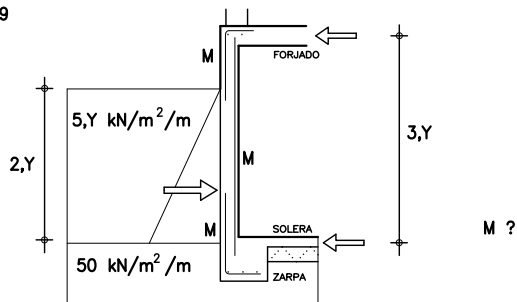
 m kN

10

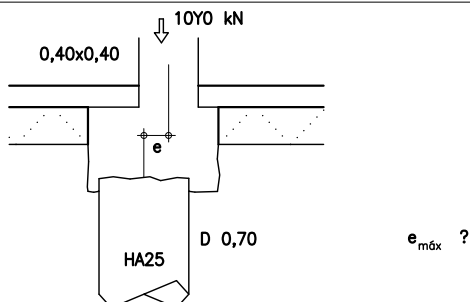
 m